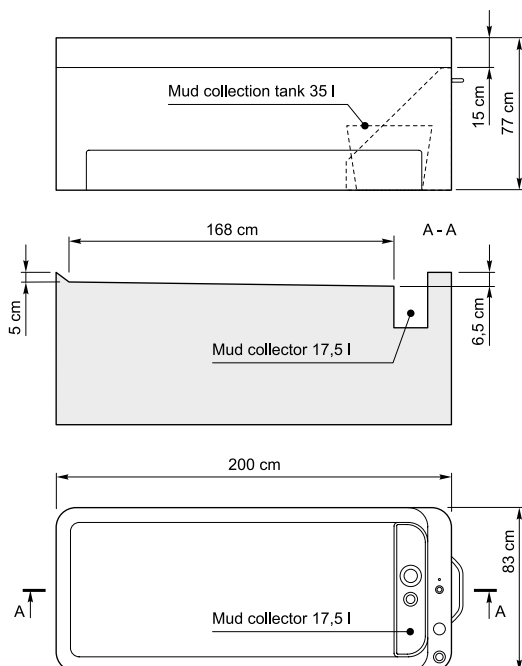
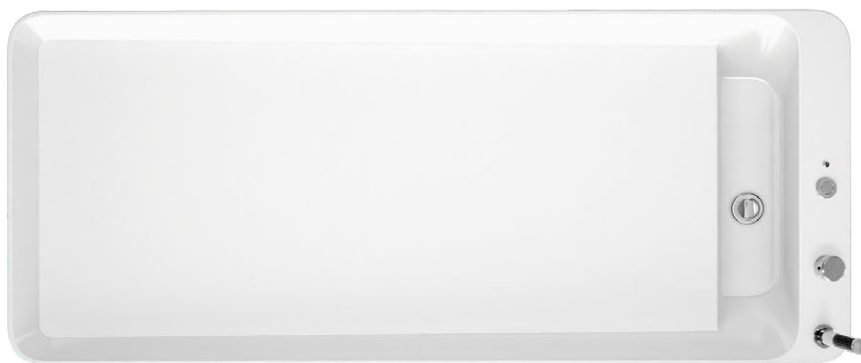

TABLE FOR WRAP PROCEDURES



TROLLEY WITH MUD COLLECTION TANK



MEASURES FOR COMMUNICATIONS

- Drain for mud Ø 50 mm
- Drain for water Ø 50 mm
- ⊞ Hot water (1/2" stopcock max. 16 cm high from the floor)
- ⊞ Cold water (1/2" stopcock max. 16 cm high from the floor)
- ⊞ Supply wire cable (1 m long)
- ⊞ Additional earthing wire cable (1 m long)

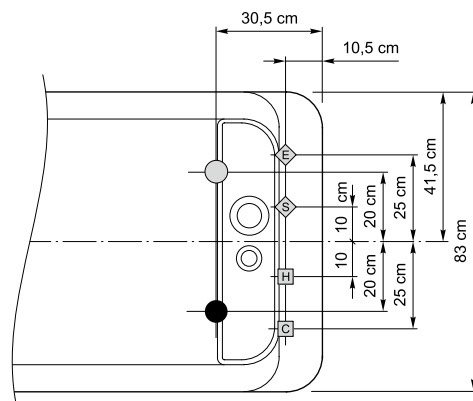

W-M-H

- Drain for water
- Drain for mud
- Table heating
- Table

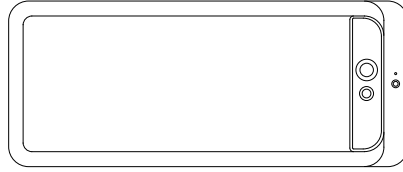

Power (kW) 0,15
 Current (A) 0,7
 Voltage (V) ~230
 Frequency (Hz) 50

W-M

- Drain for water
- Drain for mud
- Table

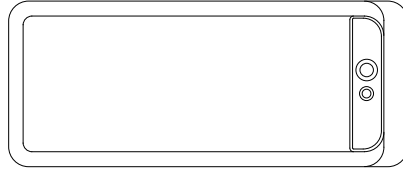

Power (kW) -
 Current (A) -
 Voltage (V) -
 Frequency (Hz) -

W-H

- Drain for water
- Table heating
- Table

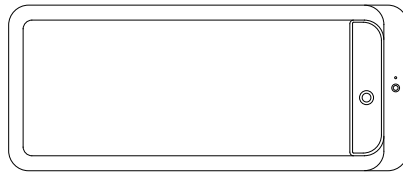

Power (kW) 0,15
 Current (A) 0,7
 Voltage (V) ~230
 Frequency (Hz) 50

W

- Drain for water
- Table

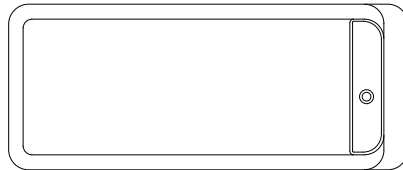

Power (kW) -
 Current (A) -
 Voltage (V) -
 Frequency (Hz) -

TABLE-H

- Table heating
- Table

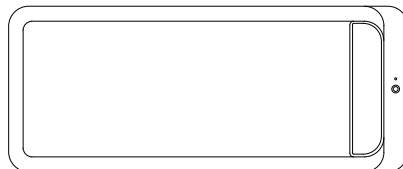

Power (kW) 0,15
 Current (A) 0,7
 Voltage (V) ~230
 Frequency (Hz) 50

TABLE

- Acrylic table
- Frame with adjustable feet
- 2 front and 2 side panels

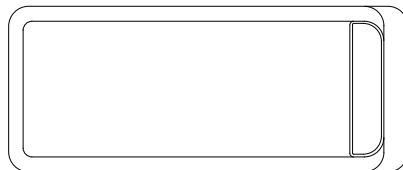

Power (kW) -
 Current (A) -
 Voltage (V) -
 Frequency (Hz) -

TECHNICAL DATA

1. MEASURES FOR CONNECTIONS OF HOT AND COLD WATER – 1/2".
2. MEASURE FOR WATER DRAIN CONNECTION – Ø 50 mm.
3. MEASURE FOR MUD DRAIN CONNECTION – Ø 50 mm.

ACCESSORIES

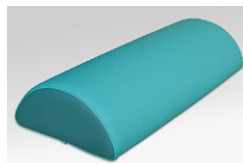

Cushion



Mattress



Mixer with handshower handle



Stairs



Trolley with mud collection tank